



SIRIUS soft starter S3 80 A, 45 kW/400 V, 40 °C 200-480 V AC, 24 V AC/DC Screw terminals Thermistor motor protection

General technical data

product brand name		SIRIUS
product feature		
• integrated bypass contact system		Yes
• thyristors		Yes
product function		
• intrinsic device protection		Yes
• motor overload protection		Yes
• evaluation of thermistor motor protection		Yes
• external reset		Yes
• adjustable current limitation		Yes
• inside-delta circuit		No
product component motor brake output		No
insulation voltage rated value	V	600
degree of pollution		3, acc. to IEC 60947-4-2
reference code according to EN 61346-2		Q
reference code according to DIN 40719 extended according to IEC 204-2 according to IEC 750		G

Power Electronics

product designation		Soft starter
operational current		
• at 40 °C rated value	A	80
• at 50 °C rated value	A	73
• at 60 °C rated value	A	66
yielded mechanical performance for 3-phase motors		
• at 230 V		
— at standard circuit at 40 °C rated value	kW	22
• at 400 V		
— at standard circuit at 40 °C rated value	kW	45
yielded mechanical performance [hp] for 3-phase AC motor at 200/208 V at standard circuit at 50 °C rated value	hp	20
operating frequency rated value	Hz	50 ... 60
relative negative tolerance of the operating frequency	%	-10
relative positive tolerance of the operating frequency	%	10
operating voltage at standard circuit rated value	V	200 ... 480
relative negative tolerance of the operating voltage at standard circuit	%	-15
relative positive tolerance of the operating voltage at standard circuit	%	10
minimum load [%]	%	20
adjustable motor current for motor overload protection minimum rated value	A	43

continuous operating current [% of I _e] at 40 °C	%	115
power loss [W] at operational current at 40 °C during operation typical	W	12

Control circuit/ Control

type of voltage of the control supply voltage		AC/DC
control supply voltage frequency 1 rated value	Hz	50
control supply voltage frequency 2 rated value	Hz	60
relative negative tolerance of the control supply voltage frequency	%	-10
relative positive tolerance of the control supply voltage frequency	%	10
control supply voltage 1 at AC		
• at 50 Hz rated value	V	24
• at 60 Hz rated value	V	24
relative negative tolerance of the control supply voltage at AC at 50 Hz	%	-15
relative positive tolerance of the control supply voltage at AC at 50 Hz	%	10
relative negative tolerance of the control supply voltage at AC at 60 Hz	%	-15
relative positive tolerance of the control supply voltage at AC at 60 Hz	%	10
control supply voltage 1 at DC rated value	V	24
relative negative tolerance of the control supply voltage at DC	%	-20
relative positive tolerance of the control supply voltage at DC	%	20
display version for fault signal		red

Mechanical data

size of engine control device		S3
width	mm	70
height	mm	170
depth	mm	190
fastening method		screw and snap-on mounting
mounting position		With additional fan: With vertical mounting surface +/- 90° rotatable, with vertical mounting surface +/- 22.5° tiltable to the front and back Without additional fan: With vertical mounting surface +/- 10° rotatable, with vertical mounting surface +/- 10° t
required spacing with side-by-side mounting		
• upwards	mm	60
• at the side	mm	30
• downwards	mm	40
wire length maximum	m	300
number of poles for main current circuit		3

Connections/ Terminals

type of electrical connection		
• for main current circuit		screw-type terminals
• for auxiliary and control circuit		screw-type terminals
number of NC contacts for auxiliary contacts		0
number of NO contacts for auxiliary contacts		2
number of CO contacts for auxiliary contacts		1
type of connectable conductor cross-sections for main contacts for box terminal using the front clamping point		
• solid		2x (2.5 ... 16 mm ²)
• finely stranded with core end processing		2.5 ... 35 mm ²
• stranded		4 ... 70 mm ²
type of connectable conductor cross-sections for main contacts for box terminal using the back clamping point		
• solid		2x (2.5 ... 16 mm ²)
• finely stranded with core end processing		2.5 ... 50 mm ²
• stranded		10 ... 70 mm ²
type of connectable conductor cross-sections for main contacts for box terminal using both clamping points		

<ul style="list-style-type: none"> • solid • finely stranded with core end processing • stranded 	<p>2x (2.5 ... 16 mm²) 2x (2.5 ... 35 mm²) 2x (10 ... 50 mm²)</p>
<p>type of connectable conductor cross-sections at AWG cables for main contacts for box terminal</p> <ul style="list-style-type: none"> • using the back clamping point • using the front clamping point • using both clamping points 	<p>2x (10 ... 1/0) 2x (10 ... 1/0) 10 ... 2/0</p>
<p>type of connectable conductor cross-sections for DIN cable lug for main contacts</p> <ul style="list-style-type: none"> • finely stranded • stranded 	<p>2 x (10 ... 50 mm²) 2x (10 ... 70 mm²)</p>
<p>type of connectable conductor cross-sections for auxiliary contacts</p> <ul style="list-style-type: none"> • solid • finely stranded with core end processing 	<p>2x (0.5 ... 2.5 mm²) 2x (0.5 ... 1.5 mm²)</p>
<p>type of connectable conductor cross-sections at AWG cables</p> <ul style="list-style-type: none"> • for main contacts • for auxiliary contacts • for auxiliary contacts finely stranded with core end processing 	<p>2x (7 ... 1/0) 2x (20 ... 14) 2x (20 ... 16)</p>

Ambient conditions

<p>installation altitude at height above sea level</p>	m	5 000
<p>environmental category</p> <ul style="list-style-type: none"> • during transport according to IEC 60721 • during storage according to IEC 60721 • during operation according to IEC 60721 		<p>2K2, 2C1, 2S1, 2M2 (max. fall height 0.3 m) 1K6 (only occasional condensation), 1C2 (no salt mist), 1S2 (sand must not get inside the devices), 1M4 3K6 (no formation of ice, no condensation), 3C3 (no salt mist), 3S2 (sand must not get into the devices), 3M6</p>
<p>ambient temperature</p> <ul style="list-style-type: none"> • during operation • during storage 	°C	-25 ... +60
	°C	-40 ... +80
<p>derating temperature</p>	°C	40
<p>protection class IP on the front according to IEC 60529</p>		IP20
<p>touch protection on the front according to IEC 60529</p>		finger-safe, for vertical contact from the front

Certificates/ approvals

General Product Approval	EMC
--------------------------	-----



[Confirmation](#)



Test Certificates	Marine / Shipping	other
-------------------	-------------------	-------

[Special Test Certificate](#)

[Type Test Certificates/Test Report](#)



[Confirmation](#)

Railway

[Vibration and Shock](#)

[Confirmation](#)

UL/CSA ratings

yielded mechanical performance [hp] for 3-phase AC

motor

- at 220/230 V
 - at standard circuit at 50 °C rated value
- at 460/480 V
 - at standard circuit at 50 °C rated value

contact rating of auxiliary contacts according to UL

hp	25
hp	50
	B300 / R300

Further information

Simulation Tool for Soft Starters (STS)

<https://support.industry.siemens.com/cs/ww/en/view/101494917>

Information- and Downloadcenter (Catalogs, Brochures,...)

<https://www.siemens.com/ic10>

Industry Mall (Online ordering system)

<https://mall.industry.siemens.com/mall/en/en/Catalog/product?mlfb=3RW4046-1TB04>

Cax online generator

<http://support.automation.siemens.com/WW/CAXorder/default.aspx?lang=en&mlfb=3RW4046-1TB04>

Service&Support (Manuals, Certificates, Characteristics, FAQs,...)

<https://support.industry.siemens.com/cs/ww/en/ps/3RW4046-1TB04>

Image database (product images, 2D dimension drawings, 3D models, device circuit diagrams, EPLAN macros, ...)

http://www.automation.siemens.com/bilddb/cax_de.aspx?mlfb=3RW4046-1TB04&lang=en

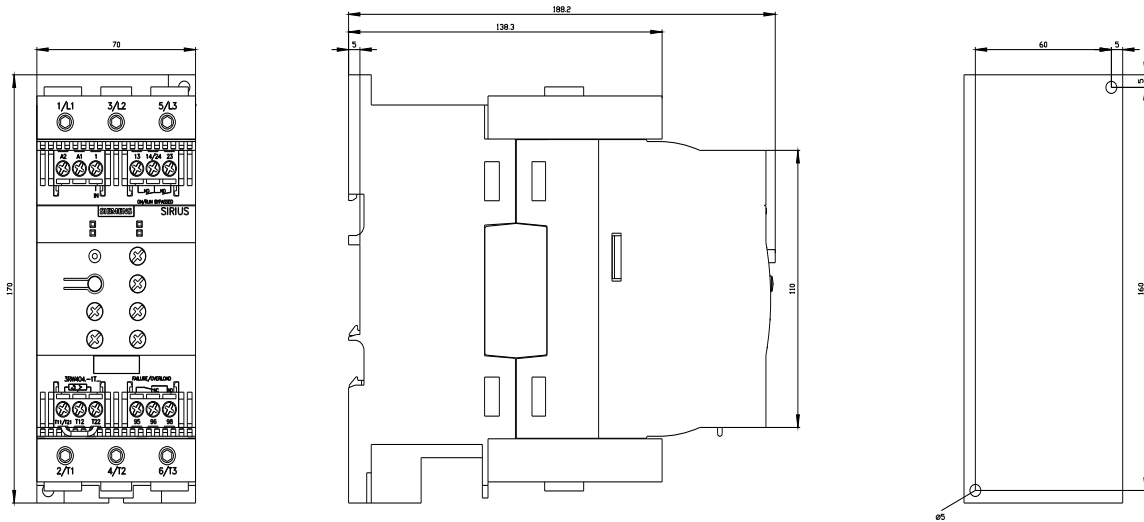

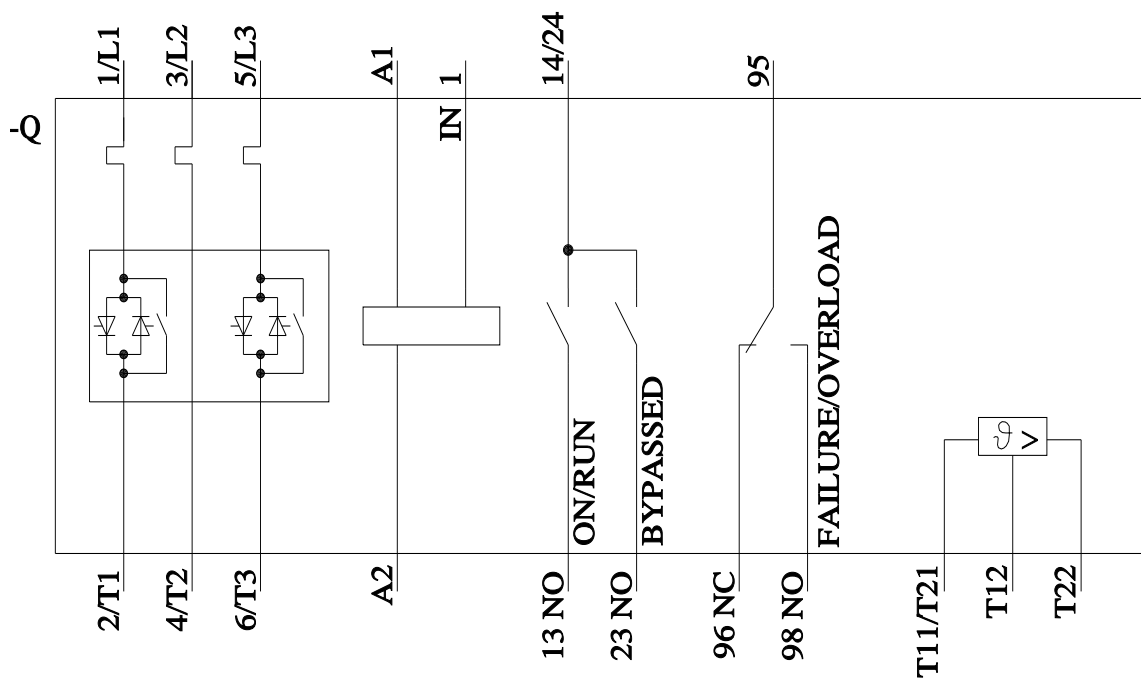

last modified:

10/28/2022 